

## **Aspect™ Sheet Installation Guide**

We've developed this installation guide to give you step-by-step instructions for a successful do-it-yourself installation of Aspect backsplash and wall panels. Please read this installation manual in it's entirety before you start and then carefully consider your experience using the tools and taking the precautions referred to herein.

If you have doubts about doing this installation, you should contact a qualified contractor or a professional installer. If you have other installation or technical questions, call our toll-free customer support line at (800) 434-3750. Additional information about ACP and its products can be found online at [www.acpideas.com](http://www.acpideas.com).

*ACP AND ITS AFFILIATES DO NOT MAKE ANY WARRANTIES, EXPRESSED OR IMPLIED, INCLUDING MERCHANTABILITY AND FITNESS FOR PURPOSE, WITH RESPECT TO ANY SAID SUGGESTIONS. In no event shall Acoustic Ceiling Products LLC have any liability in any way related to or arising out of said suggestions and product data for direct, special, consequential or any other damages of any kind regardless whether such liability is based on breach of contract, negligence or other tort, or breach of any warranty, expressed or implied.*

### **IMPORTANT SAFETY INSTRUCTIONS:**

- Read these instructions before using this product.
- Keep these instructions for future reference.
- Heed all warnings on the product and in this guide.
- Follow all instructions.
- Do not block any ventilation openings, install in accordance with the manufacturer's instructions.

### **Safety tips:**

- Turn off the power in areas you'll be drilling to avoid electric shock.
- If you drill through a fire block or firebreak, patch it with comparable material.
- If you drill holes between floors, seal them with fire-resistant caulk per National Electric Code standards.
- Before using any tools described in this manual, please be sure you know and understand the tool's use and safety precautions.

### **Tools required (use photos or drawings?)**

- Measuring tape
- Router (hand-held)
- Straight edge
- Pencil or other non-permanent marker
- Router bits
  - 1/2" straight bit
  - 1/4" straight bit
  - 9/16" 90 degree V-groove bit
- Jigsaw with high-quality blade\*
- Table saw or circular saw with high-quality blade\*
- Drill and 1/2" drill bit
- Approved adhesive\*\*
- Notched trowel (1/4")

- Rubbing alcohol
- Removable tape
- Clamps (spring, “C” or bar clamps will work to hold material in place while adhesive sets)
- Paper towels
- Soft cloth
- fine-grit sandpaper (200 – 600 grit)

\* see “saw cutting” section below for details on blade requirements.

\*\* see last page for approved adhesives specifications

Before installation begins, clean the surfaces to be covered in Aspect material. Make sure all surfaces are clean, dry, smooth, and free from dust, grease, wax, etc.

### **Project Planning**

- Plan your installation. Will you need to cut around corners, cabinets or electrical outlets? Often these areas provide a good place for a seam between panels.
- Do you plan to use a single color or style or do you want to alternate the colors?
- Be sure you have enough Aspect surface paneling material.
- Be sure you also have enough adhesive. See the adhesive manufacturer’s directions to determine the coverage area.

### **1) Cutting the panels:**

#### **Overview:**

Aspect material can be cut using various methods common to both the metal and woodworking industries. These methods include cutting with table saws, panel saws, multiple operation rip/V-grooving saws, portable circular saws, reciprocating and band saws, and routing and shearing equipment. No cutting lubricants, oils or coolants are required with any of these cutting operations. Aspect material cannot be cut with a knife.

Using a circular saw for the long straight cuts and a router for corners is the most common and one of the easiest methods. We recommend a router and circular saw for your installation project.

#### **Saw Cutting**

Aspect material is manufactured with a polyester paint finish. Care should be taken to protect the finish during any sawing operation. In most cases it is best to move the saw blade rather than the Aspect material when cutting the panels.

Table saws are not recommended for cutting sheets larger than 4' x 4' in size.

Blades should be **Carbide-tipped** or **High-speed steel** designed for cutting nonferrous materials.

Portable circular saws are also used effectively to cut Aspect material. These saws should be heavy-duty type equipment. Blades should be the same type used for table saws.

Reciprocating saws (jigsaws) work well for cutouts. Care should be taken with portable and reciprocating saws to prevent damage to the Aspect material surface. More than one sheet can be cut at a time by stacking panels. Always start an internal cut using a reciprocating saw by drilling holes in the corners of the cutout. This will allow you to insert the saw blade. Blades should be high speed steel. (It is recommended when using a jigsaw that you use a back-cut blade that cuts on the up-stroke rather than the down-stroke)

### **Edges and bending**

Aspect panels can be bent in unique ways for inside and outside corners. These corners will require the use of a router to remove a channel from the back layer of aluminum and some of the composite core. When a channel is removed as described, the panel can be bent by hand for corners.

Aspect panels are designed to achieve a custom edge. By cutting or routing the back side of the panel short of cutting through the front of the panel, you can bend the remaining front layer into a professional looking finished edge

To fabricate a finished edge, you will need to remove 1/4" of the back layer of aluminum and composite core on the back side of the desired edge. Use a straight-edge to route out the channel. When routing is complete, simply bend the edge over with your hand. Be careful to roll over the edge incrementally all the way across for the best results. *See diagram for more information below?*

### **Routing**

Overview:

The two-sided panels are unique in that you can cut channel(s) out of the metal from the backside of the aluminum skin to achieve professional-looking bends for corners and edges.

We recommend you use a portable hand router to achieve bends for inside and outside corners and edges. Bits should be carbide-tipped and kept sharp. Single or multiple flutes may be used.

### **Routing: For Bending**

Aspect material can be accurately folded by hand after a simple routing operation is done on the back skin. This fabrication method is called "rout and return." It is unique to composite panel fabrication.

Always use a steel straight edge or similar tool when routing. Clamp the straight edge to the Aspect material and use it as a guide to achieve straight cuts with the router.

The material may be routed for bending by using the following method:

1. Hand-operated routers equipped with modified 90-105 degree "V" bits (See figure 1) can be used effectively to remove material for bending.

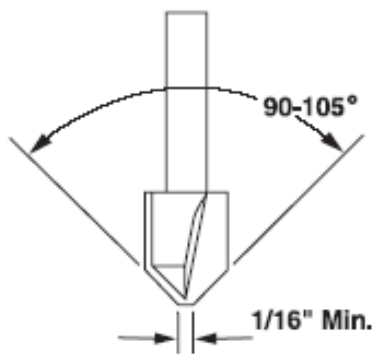

**FIGURE 1**

1/16" flat ground on bottom of commercially available wood working router bit.

### Small Radius Bending (by routing)

A very small radius can be achieved by "V" routing and folding. The depth of the "V" rout is critical. As a general guideline, the exterior aluminum skin should be visible through the polyethylene core at the valley of the rout; this visual appearance should be consistent along the entire length of the rout.

Constant depth of the rout ensures a good smooth line when the fold is made. Extreme care should be taken not to score the exterior aluminum skin with the router bit.

### **Making Corners**

#### Common 90° V-Routed Corner

The most common corner is a 90° Rout and Return. This corner is made by folding a V-Routed panel to a 90° angle. It is critical that the modified V-Rout is made to the correct depth to create a good return angle. "Spring back" will occur if the rout is not deep enough, however, extreme care should be taken not to score the exterior aluminum skin with the router bit or blade during the routing operation so that the aluminum skin is not weakened. The depth is correct when the exterior skin is intact with approximately 1/64" of polyethylene in the bottom of the V-Rout and the return does not "spring back" when folded.

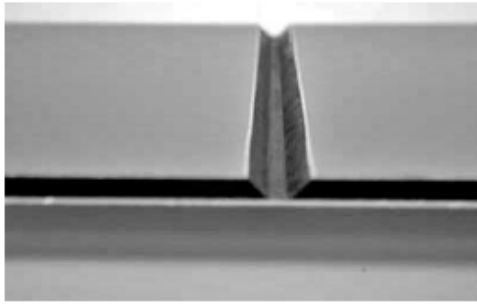

“V-route” in Aspect

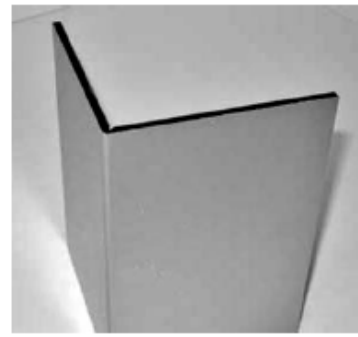

Folded “V-route” corner

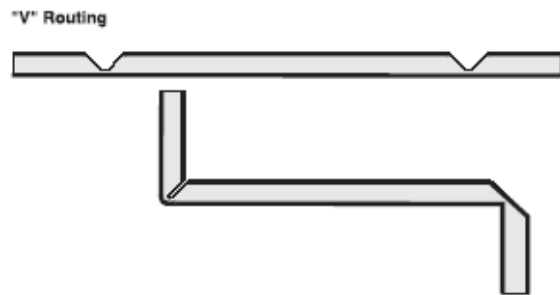
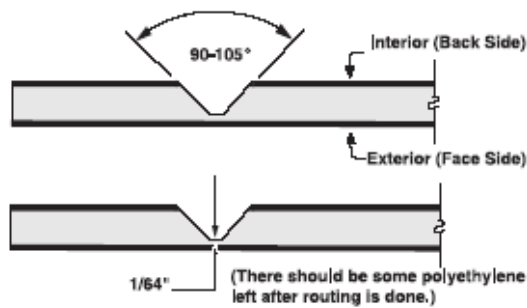

Alternatively, you can choose to have **larger-radius corners** by using a different router bit. You will need a flat router bit available at your home center or hardware store. Use a flat bit from 1/4” to 5/8” depending on the radius you want to achieve. The larger the bit, the larger the radius will be.

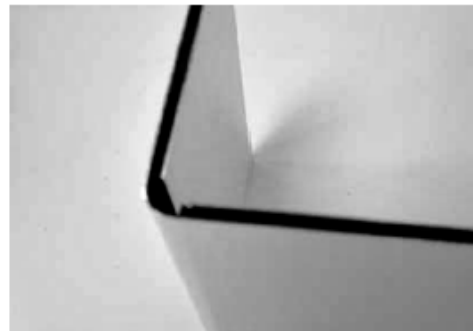
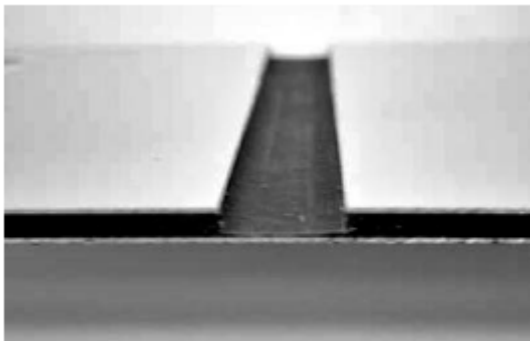
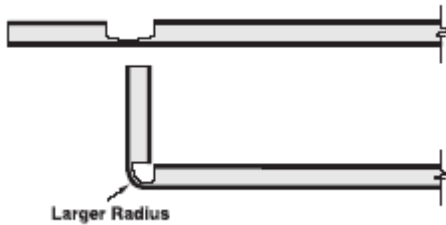

Panel cutting

Depending on which router bits and corner radius you use, the measurement will vary. For example, when using a small-radius “V-route” corner, you will need to add approximately ¼” to your measurement on outside corners. Add approximately 3/8” to outside corner measurements when using large-radius cornering.

### **Measure and lay-out**

Measure the first area to be covered by Aspect material. Lay-out your first panel. Using a pencil or other temporary marker, transfer the measurements to the first panel according to your particular application.

Be sure to plan for bends, corners or edge treatments before cutting. Any edges can be routed out and left for a finishing bend after the panels have been installed. You will need to add ¼” to 3/8” to the panel measurement if you plan to fabricate rolled edges.

When cutting around electrical outlets or other obstructions, use a reciprocating saw or handheld “jigsaw.” Be sure to use a proper blade as discussed previously in the “saw cutting” section.

Using one of the methods from the “Cutting” section above, prepare to cut the first panel. When cutting is complete, use a fine-grit sandpaper or a small metal file to debur the newly cut edges.

Carefully transport the cut panels to the work space and place the panel in its intended location to verify that it fits properly.

### **Installing your first panel**

Begin to apply the Aspect panels from an inside corner, working outwards and upwards. An exception to this rule would be designing layout of panels to be centered at a focal point, such as behind a sink or stove area. In this case, build out from both sides of the focal point, symmetrically.

Once it has been determined that all cut pieces fit properly, remove any protective film on the back side of the Aspect material. Clean the back of the panel to be installed with rubbing alcohol. Be sure the substrate is clean and dry.

### **Apply adhesive**

**Always follow the adhesive manufacturer’s directions. Please see the adhesive specifications section at the end of this instruction manual before proceeding.**

Adhesive will vary in their "set up" times.

Some products may require longer direct pressure times to hold backsplash panels in place. Please refer to the manufacturer's product specifications for set and dry times. Many will recommend that you apply the adhesive, press the backsplash panel in place, and then pull it away for a few seconds; they re-apply the panel with direct pressure. This process aids in the "set up" of the adhesive.

Once in place, press your hands firmly across the panel repeatedly to ensure proper contact with the backsplash panel, adhesive, and wall surface. If an area "pulls" away, re-apply pressure to that area. Continue to press panel into its place against the substrate until the adhesive has made contact with the intended substrate. Use a soft cloth to apply pressure evenly across the panel and squeeze out the excess air.

### **Clean up**

Wipe off excess adhesive: with a damp sponge or cloth, clean off any adhesive residue that is visible while it is still wet. Do not allow this residue to dry as it will be very hard to clean up when dry.

### **Keep in place**

Placing temporary bracing, clamps or taping the edges with removable tape will help hold the backsplash in place when using slow-drying adhesives.

Mechanical fasteners such as screws or nails can also be used to apply the panels. For mechanical fasteners, drill a pilot hole first and then install small screws or designer nails along the perimeter of the backsplash panel. Or you can create a seam, line or other design. We recommend you only use non-corrosive mechanical fasteners composed of aluminum, plastic or stainless steel.

Finish installing your panels: add additional panels in the same fashion.

After the adhesive has set up according to the manufacturer's directions, the exposed edges can now be bent over to achieve a professional finishing touch.

### **Adhesive Technical Information**

#### Adhesives Used with Aspect Material

One of the display features in great demand is the ability to attach Aspect Material to a substrate without having exposed fasteners. Although there are some techniques to accomplish this by using conventional fasteners, the vast majority of this type connection is done using adhesives.

To develop some general guidelines, we have reviewed some well-known adhesives and can present the following information.

The following General Guidelines have been established based on the research done into the use of adhesives on Aspect material.

1. To achieve reliable bonding, it is imperative to follow the adhesive manufacturer's application instructions.
2. Although many adhesive materials work well on the coil coated paint finishes on Aspect Material, no product, either adhesive or tape, has been found that will adhere to

the polyethylene core material. All attachments should be made through contact with the painted aluminum facers of Aspect material.

3. Care must be taken in the selection of an adhesive regarding the thermal expansion of the materials to be joined. Where significant thermal expansion can occur (i.e. exterior applications) adhesives should be of medium or low modulus materials to allow for movement without shear or loss of bond. For interior applications where thermal expansion is not a consideration, high modulus adhesives can be used to join materials.

4. Cure time is generally a consideration in the choice of adhesives. Silicones take a good deal of time to cure before a load can be applied whereas the faster curing adhesives do not have the movement capabilities to meet the project needs. In these instances, a combination of double sided foam tape and adhesive is often used. Example: Two pieces of Aspect Material must be connected for a strong permanent bond in a short period of time. The adhesive area is 2" by 36". Many times a strip of double sided foam tape (approx. 3/4" wide) will be applied next to a bead of silicone adhesive. For the near term, the tape holds the Aspect material. For the longer term, the silicone adhesive will cure and relieve the load applied to the tape.

#### Adhesive Research Results

The following adhesives have been shown to adhere to Aspect Material. For specific questions about the adhesive, please refer to the adhesive manufacturer guidelines. Isopropyl alcohol two-cloth cleaning method is a minimal surface preparation for all adhesive bonding.

#### **Brand names of recommended adhesives in bold**

1-Part Silicones, Adhesives and Sealants:

- **Dow 995**: 1-part silicone structural adhesive
  - **Pecora 864, 890, 895**: **1-part silicone sealant**
  - **Tremco Spectrem 1, Spectrem 2, Proglaze SG**: 1-part silicone sealant
  - **Schnee Morehead SM5731**, 1-part silicone sealant
  - **GE SCS2800, SCS9000, SCS2000, SCS2900, GE7000**, 1-part silicone sealant
- Isopropyl alcohol two-cloth cleaning method is a minimal surface preparation for all adhesive bonding.

1-Part Silicones or Urethane Adhesives/Sealants Requiring a Primer:

- **Dow 790, Dow 795**: 1-part silicone sealant
- Surface preparation: solvent wipe and Dow Corning 1200 Prime Coat required.
- **Tremco Dymonic**: 1-part polyurethane sealant
- Surface preparation: Isopropyl alcohol two-cloth cleaning method, primer #6

2-Part Methacrylate, Urethane, and Epoxy Adhesives:

- **Lord 406/19** (methacrylate), 7542AB, 7545AB (urethane)
- **Extreme Adhesives 300, 310, 350, 5315, 5375** methyl methacrylate
- **IPS Weld-On 45, Weld-On SS515** (methacrylate)
- **Scotch Weld 3M 2216** (epoxy with long working time): Scuffing required

Isopropyl alcohol two-cloth cleaning method is a minimal surface preparation for all adhesive bonding.

The adhesive manufacturers have reported that, Lord 406/19 and IPS Weld-On 45 may also be used on unprimed aluminum.

Testing on this substrate was not included in this report.

Synthetic Rubber and 1-Part Urethane Adhesives:

- **Lord 7610** (1-part urethane): Scuffing required
- **Schnee-Morehead SM7108** (1-part urethane)
- **Liquid Nails LN-901** (synthetic rubber)

Isopropyl alcohol two-cloth cleaning method is a minimal surface preparation for all adhesive bonding.

Acrylic Foam Tape:

- **3MTM 4845** Acrylic Foam
- YHB Tapes

### Summary

Many different types of adhesives and tapes have been found to work well with Aspect Material. It is important to follow the guidelines listed above and to experiment with any new adhesive or technique prior to generating the final product.